

Varenummer: 390204900742236
 Beskrivelse: Snekkegear med skridnav
 VF 49-L2-F-7 P63B5

Mål

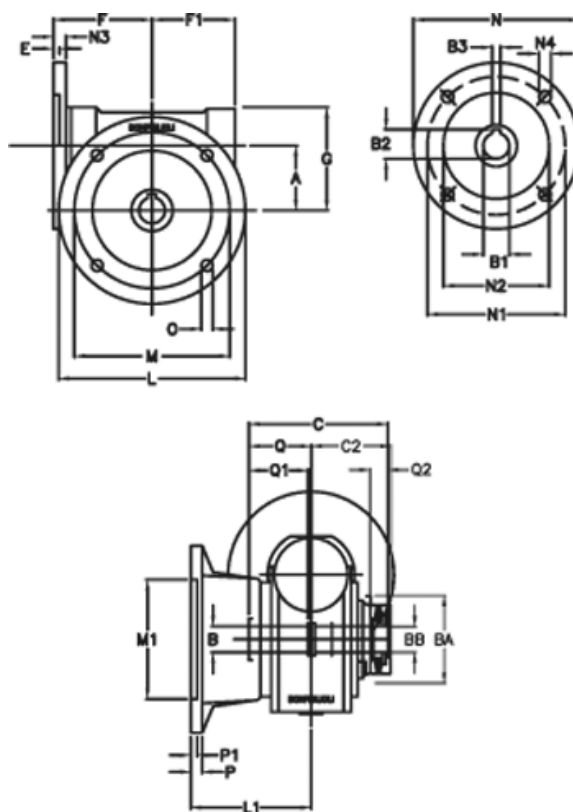

a	= 49.50	C	= 105	m	= 90	P	= 12
B	= 25	C2	= 63,5	M1	= 70	P1	= 10
B1 E7	= 11	E	= 3.0	N	= 140	Q	= 51.0
B2	= 12.8	F	= 70	N1	= 115	Q1	= 41
B3 H9	= 4	F1	= 63	N2	= 95	Q2	= 15
BA	= 63	g	= 80	N3	= 10.5		
BB H7	= 14	L	= 125	N4	= 9.5		
Betegnelsen	= VF 49F-xx-63B5	L1	= 85.5	O	= 10.5		